



杭州络丰科技有限公司

HANGZHOU ROLL FORMING TECHNOLOGY CO., LTD

PROFILE COLLECTION

www.hzrollforming.com

杭州络丰科技有限公司

HANGZHOU ROLL FORMING TECHNOLOGY CO., LTD

地址：浙江省杭州市萧山区经济技术开发区东方世纪中心1804室

邮编：311215

电话：+86-571-82686709

手机：+86 13208010152 +86 15381181423

网址：www.hzrollforming.com

邮箱：info@chinacoldrollforming.com

Hangzhou Roll Forming Technology Co., Ltd

Add: Room 1804, Dongfang Century Center, Economic and Technological Development Zone,
Xiaoshan District, Hangzhou City, Zhejiang, P.R. China, 311215

Postcode: 311215

Tel: +86-571-82686709

Mob: +86 13208010152 +86 15381181423

Website: www.hzrollforming.com

E-mail: info@chinacoldrollforming.com

杭州络丰科技有限公司

HANGZHOU ROLL FORMING TECHNOLOGY CO., LTD

目录 CONTENTS

琉璃瓦板系列	01
Tile Series	
屋面/墙面板系列	07
Roof / Wall Series	
波纹板系列	13
Wave Panel Series	
咬合、隐藏式屋面、墙面板系列	15
Self-locked / Joint-hidden Roof / Wall Series	
钢楼板系列	20
Deck Series	
落水管系列	25
Water Pipe Series	
C型檩条	27
C-shape Purlins	
Z型檩条	28
Z-shape Purlins	
M型檩条	29
M-shape Purlins	
门框线系列	30
Door Frame Series	
公路护栏板系列	31
Guard Rail Series	
货架系列	35
Shelf Frame Series	
集装箱板	36
Container Panel	
屋脊机系列	37
Roof Ridge Series	
其他板形及辅助件	41
Others and Accessories	



立体效果图
Stereo view

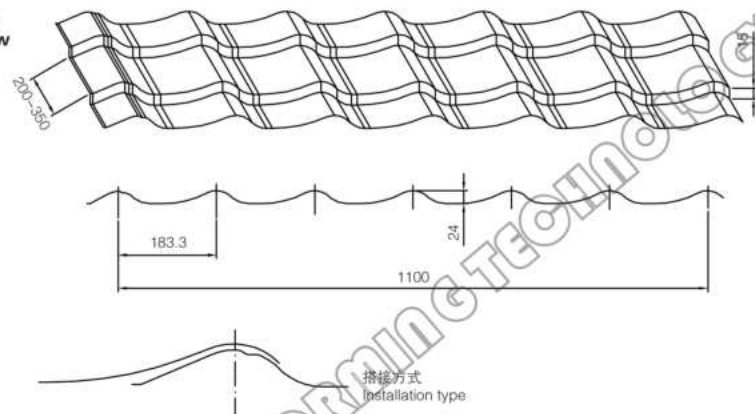

型号 Model	有效覆盖宽度 (mm) Cover width	展开宽度 (mm) Coil width	板厚 (mm) Thickness
RFT183	1100	1250	0.4
			0.6

立体效果图
Stereo view

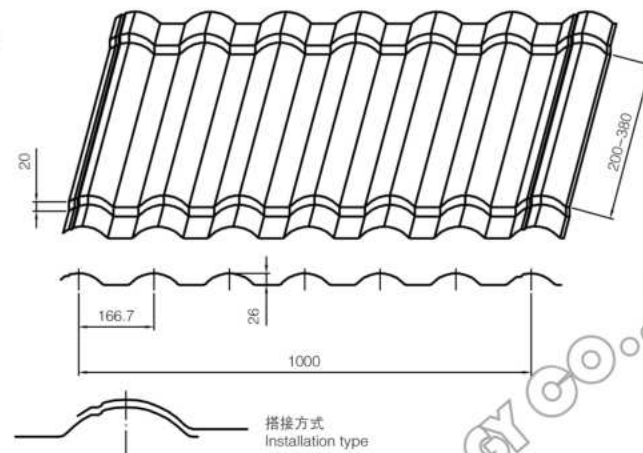

型号 Model	有效覆盖宽度 (mm) Cover width	展开宽度 (mm) Coil width	板厚 (mm) Thickness
RFT167	1000	1250	0.4
			0.6

立体效果图
Stereo view

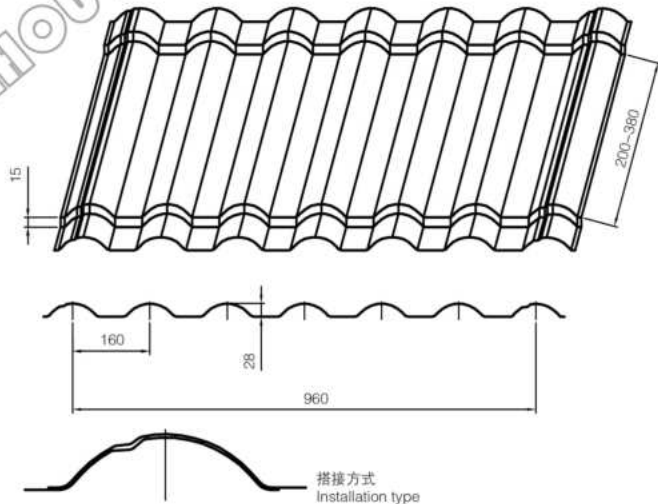

型号 Model	有效覆盖宽度 (mm) Cover width	展开宽度 (mm) Coil width	板厚 (mm) Thickness
RFT160	960	1200	0.4
			0.6

立体效果图
Stereo view

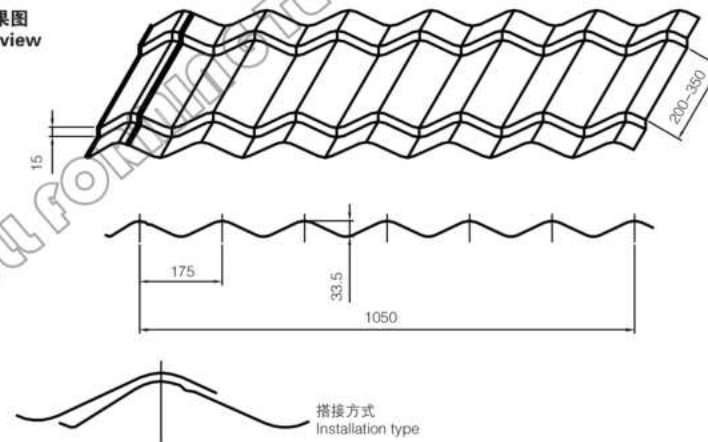

型号 Model	有效覆盖宽度 (mm) Cover width	展开宽度 (mm) Coil width	板厚 (mm) Thickness
RFT175	1050	1250	0.4
			0.7



立体效果图
Stereo view

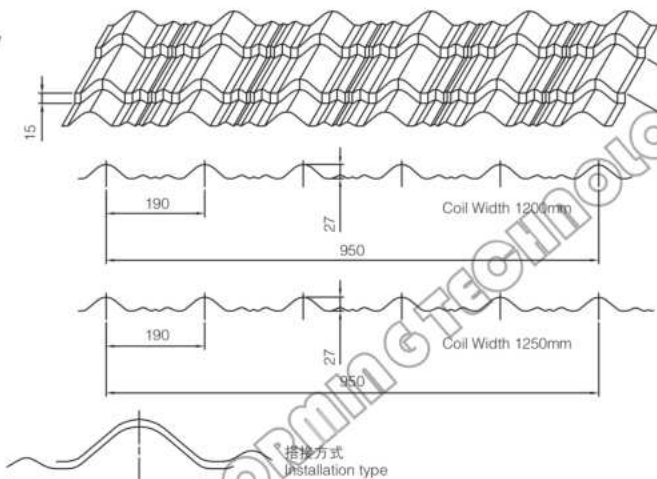

型号 Model	有效覆盖宽度 (mm) Cover width	展开宽度 (mm) Coil width	板厚 (mm) Thickness
RFT190	950	1200-1250	0.4 0.6

立体效果图
Stereo view

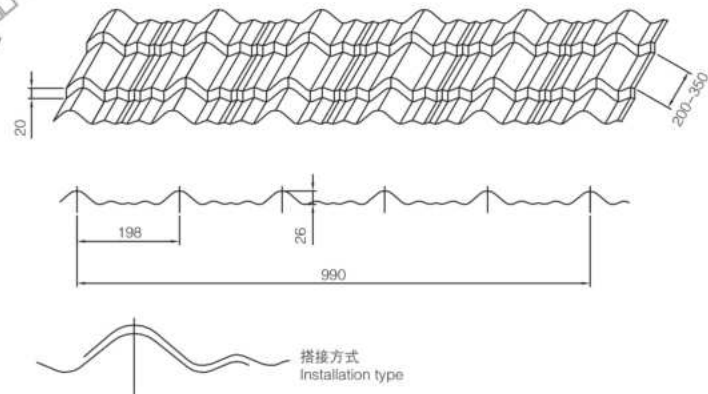

型号 Model	有效覆盖宽度 (mm) Cover width	展开宽度 (mm) Coil width	板厚 (mm) Thickness
RFT198	990	1220	0.4 0.6



立体效果图
Stereo view

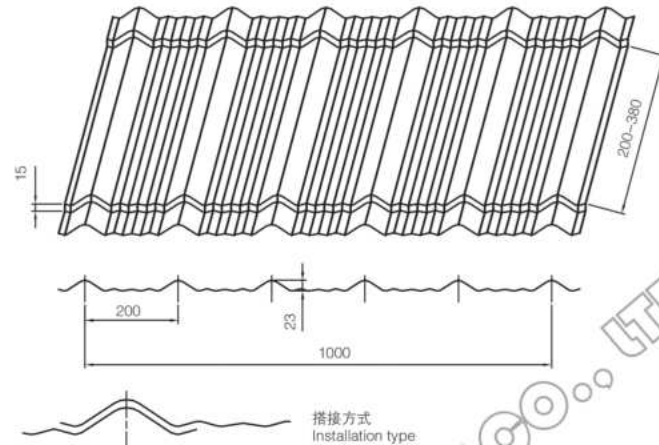

型号 Model	有效覆盖宽度 (mm) Cover width	展开宽度 (mm) Coil width	板厚 (mm) Thickness
RFT200	1000	1200	0.3 0.7

立体效果图
Stereo view

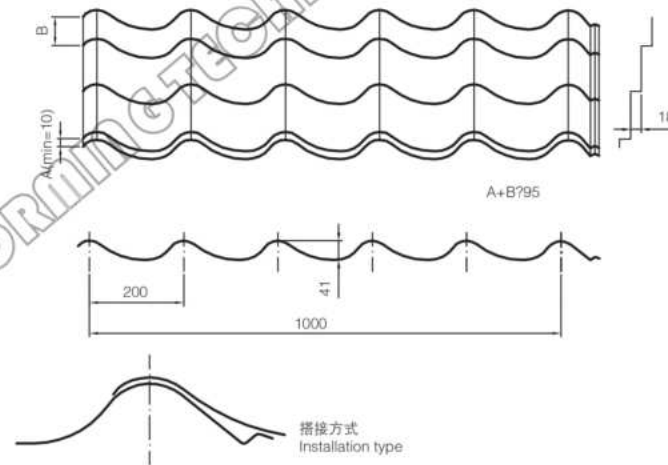

型号 Model	有效覆盖宽度 (mm) Cover width	展开宽度 (mm) Coil width	板厚 (mm) Thickness
RFT200	1000	1219	0.4 0.6



立体效果图
Stereo view

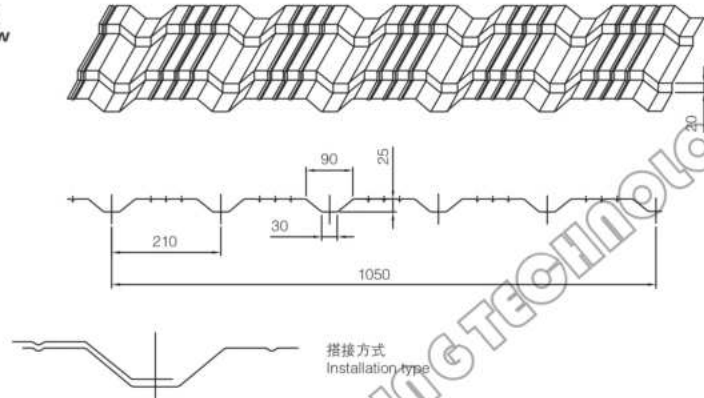

搭接方式
Installation type

型号 Model	有效覆盖宽度 (mm) Cover width	展开宽度 (mm) Coil width	板厚 (mm) Thickness
RFT210	1050	1250	0.5 0.6

立体效果图
Stereo view

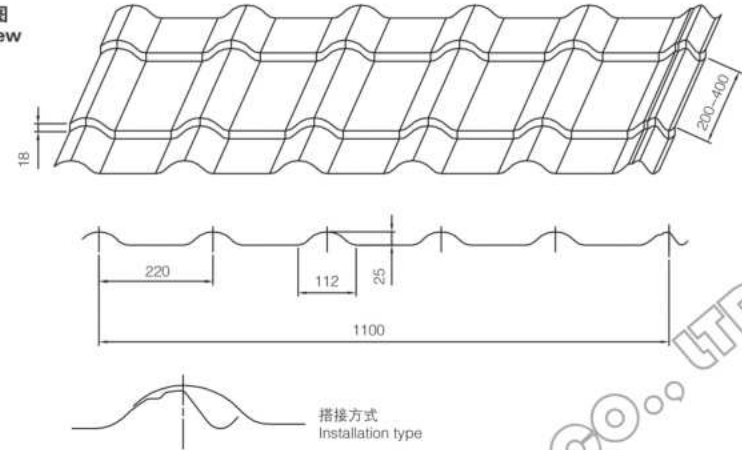

搭接方式
Installation type

型号 Model	有效覆盖宽度 (mm) Cover width	展开宽度 (mm) Coil width	板厚 (mm) Thickness
RFT220	1100	1250	0.4 0.6

立体效果图
Stereo view

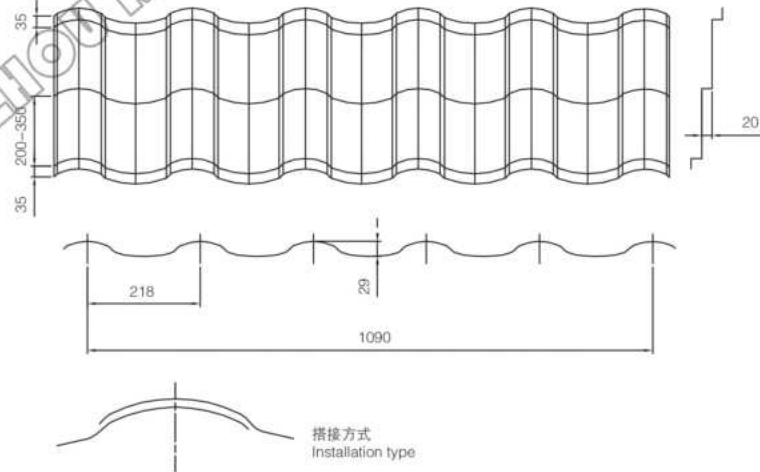

搭接方式
Installation type

型号 Model	有效覆盖宽度 (mm) Cover width	展开宽度 (mm) Coil width	板厚 (mm) Thickness
RFT218	1090	1250	0.4 0.6

立体效果图
Stereo view

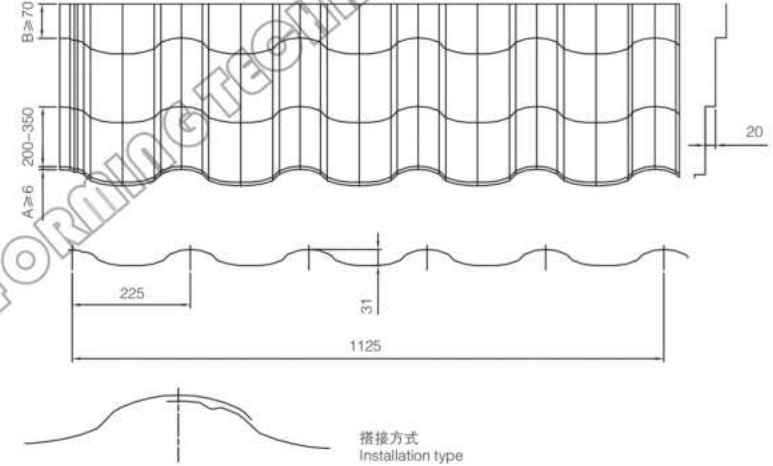

搭接方式
Installation type

型号 Model	有效覆盖宽度 (mm) Cover width	展开宽度 (mm) Coil width	板厚 (mm) Thickness
RFT225	1125	1250	0.4 0.6

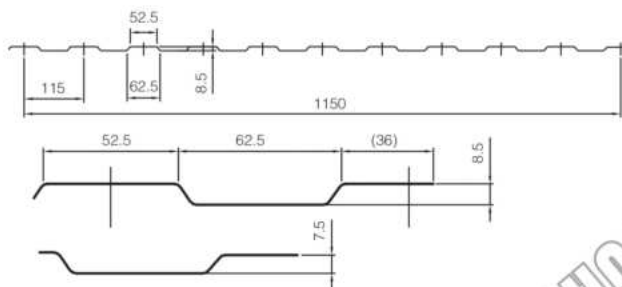

型号 Model	有效覆盖宽度 (mm) Cover width	展开宽度 (mm) Coil width	板厚 (mm) Thickness	用途 Usage
RFT115(C8)	1150	1250	0.4	屋面板 Roof
			0.7	

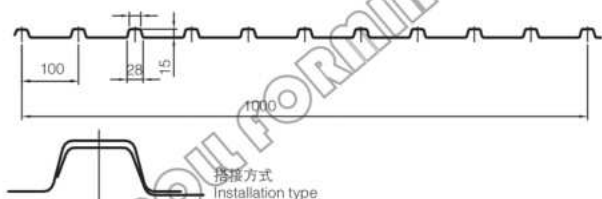

型号 Model	有效覆盖宽度 (mm) Cover width	展开宽度 (mm) Coil width	板厚 (mm) Thickness	用途 Usage
RFT100(C15)	1000	1250	0.4	屋面板 Roof
			0.8	

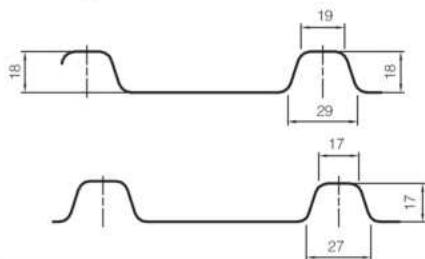

型号 Model	有效覆盖宽度 (mm) Cover width	展开宽度 (mm) Coil width	板厚 (mm) Thickness	用途 Usage
RFT100(C18)	1000	1250	0.4	屋面板 Roof
			0.8	

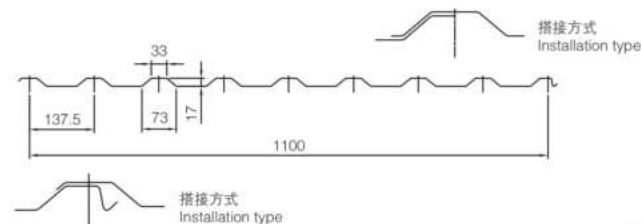

型号 Model	有效覆盖宽度 (mm) Cover width	展开宽度 (mm) Coil width	板厚 (mm) Thickness	用途 Usage
RFT137(C20)	1100	1250	0.4	屋面板 Roof
			0.7	

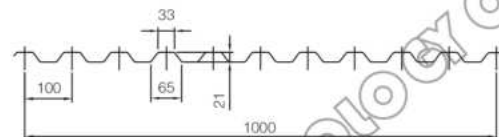

型号 Model	有效覆盖宽度 (mm) Cover width	展开宽度 (mm) Coil width	板厚 (mm) Thickness	用途 Usage
RFT100(C21)	1000	1250	0.4	屋面板 Roof
			0.7	

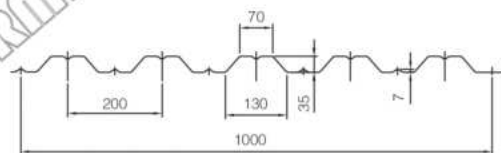

型号 Model	有效覆盖宽度 (mm) Cover width	展开宽度 (mm) Coil width	板厚 (mm) Thickness	用途 Usage
RFT200(HC35)	1000	1250	0.4	屋面板 Roof
			0.7	

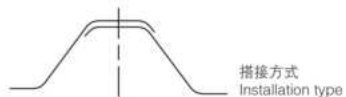
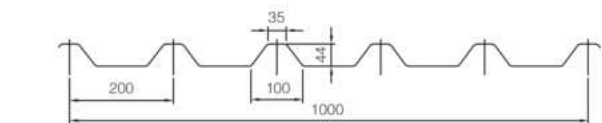

型号 Model	有效覆盖宽度 (mm) Cover width	展开宽度 (mm) Coil width	板厚 (mm) Thickness	用途 Usage
RFT200(C44)	1000	1250	0.4	屋面板 Roof
			0.7	

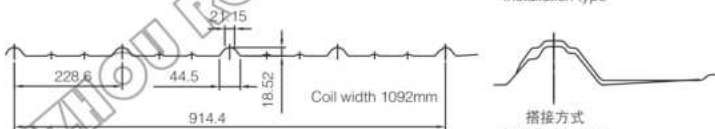
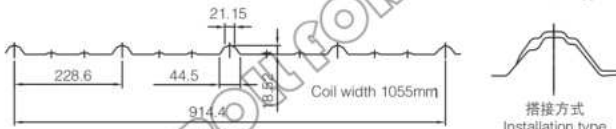
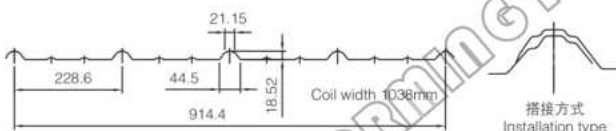

型号 Model	有效覆盖宽度 (mm) Cover width	展开宽度 (mm) Coil width	板厚 (mm) Thickness	用途 Usage
RFT228A	914	1038/1055/1092	0.36	屋面板 Roof
			0.47	

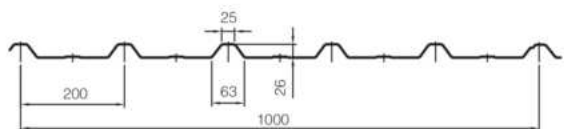

型号 Model	有效覆盖宽度 (mm) Cover width	展开宽度 (mm) Coil width	板厚 (mm) Thickness	用途 Usage
RFT200	1000	1200	0.35	屋面板 Roof
			0.7	

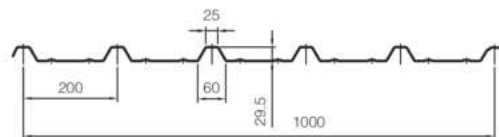
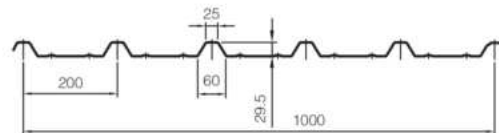

型号 Model	有效覆盖宽度 (mm) Cover width	展开宽度 (mm) Coil width	板厚 (mm) Thickness	用途 Usage
RFT200	1000	1250	0.4	屋面板 Roof
			0.8	

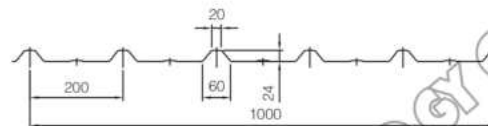

型号 Model	有效覆盖宽度 (mm) Cover width	展开宽度 (mm) Coil width	板厚 (mm) Thickness	用途 Usage
RFT200C	1000	1200	0.3	屋面板 Roof
			0.7	

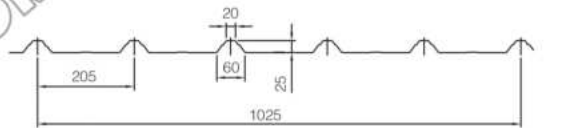
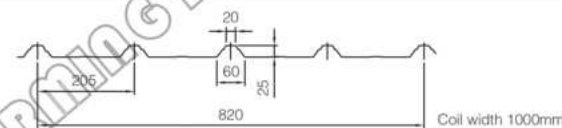

型号 Model	有效覆盖宽度 (mm) Cover width	展开宽度 (mm) Coil width	板厚 (mm) Thickness	用途 Usage
RFT205A	820/1025	1000/1250	0.4	屋面板 Roof
			0.7	

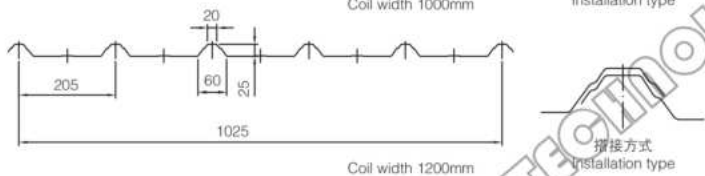
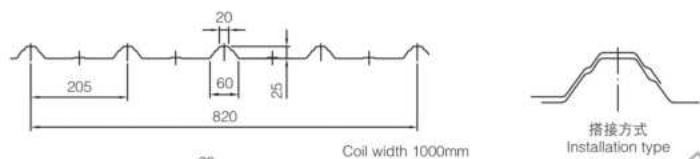

型号 Model	有效覆盖宽度 (mm) Cover width	展开宽度 (mm) Coil width	板厚 (mm) Thickness	用途 Usage
RFT205	820/1025	1000/1200	0.4	屋面板 Roof
			0.7	

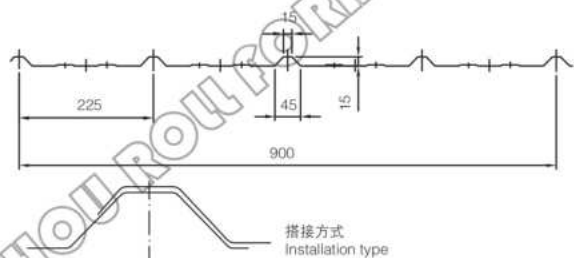

型号 Model	有效覆盖宽度 (mm) Cover width	展开宽度 (mm) Coil width	板厚 (mm) Thickness	用途 Usage
RFT225	900	1200	0.3	屋面板 Roof
			0.7	

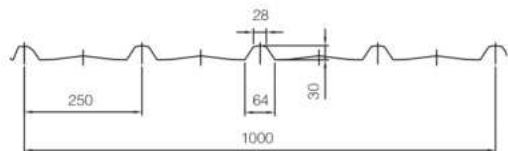

型号 Model	有效覆盖宽度 (mm) Cover width	展开宽度 (mm) Coil width	板厚 (mm) Thickness	用途 Usage
RFT250	1000	1200	0.4	屋面板 Roof
			0.7	

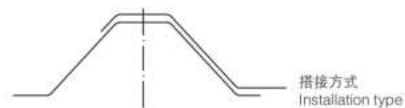
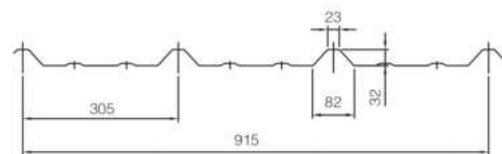

型号 Model	有效覆盖宽度 (mm) Cover width	展开宽度 (mm) Coil width	板厚 (mm) Thickness	用途 Usage
RFT305	915	1092	0.36	屋面板 Roof
			0.47	

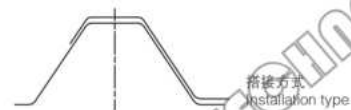

型号 Model	有效覆盖宽度 (mm) Cover width	展开宽度 (mm) Coil width	板厚 (mm) Thickness	用途 Usage
RFT333	999	1200	0.35	屋面板 Roof
			0.5	

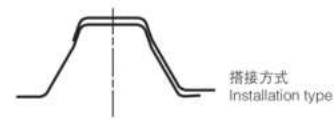
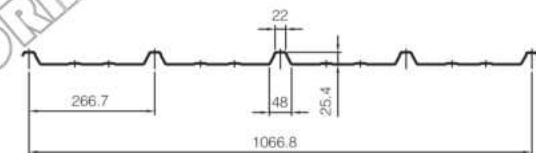

型号 Model	有效覆盖宽度 (mm) Cover width	展开宽度 (mm) Coil width	板厚 (mm) Thickness	用途 Usage
RFT266	1066	1250	0.37	屋面板 Roof
			0.61	

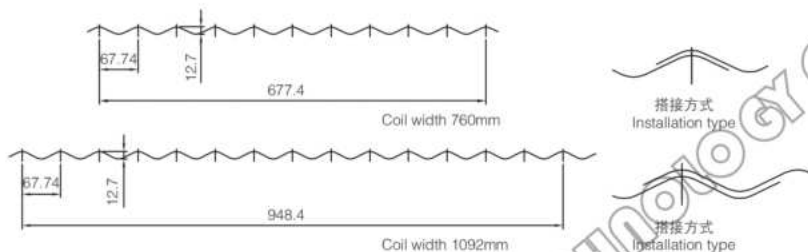

型号 Model	有效覆盖宽度 (mm) Cover width	展开宽度 (mm) Coil width	板厚 (mm) Thickness	用途 Usage
RFT66	677/948	760/1092	0.37	屋面板 Roof
			0.76	

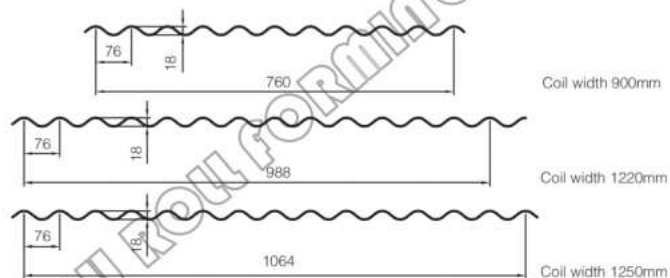

型号 Model	有效覆盖宽度 (mm) Cover width	展开宽度 (mm) Coil width	板厚 (mm) Thickness	用途 Usage
RFT76	760/988/1064	900/1220/1250	0.4	屋面板 Roof
			0.6	

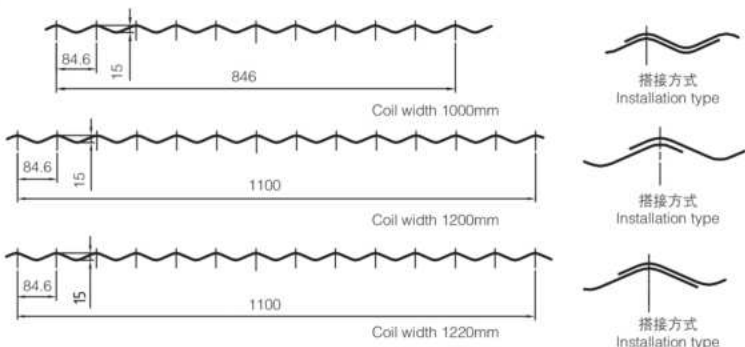

型号 Model	有效覆盖宽度 (mm) Cover width	展开宽度 (mm) Coil width	板厚 (mm) Thickness	用途 Usage
RFT84	846/1100	1000/1200/1220	0.4	屋面板 Roof
			0.8	

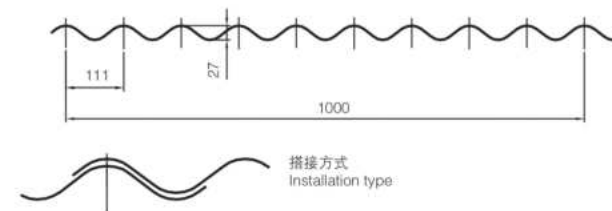

型号 Model	有效覆盖宽度 (mm) Cover width	展开宽度 (mm) Coil width	板厚 (mm) Thickness	用途 Usage
RFT111	1000	1250	0.45	屋面板 Roof
			0.75	

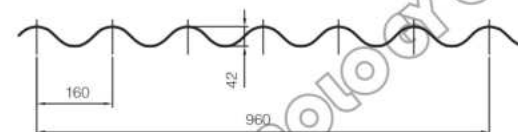

型号 Model	有效覆盖宽度 (mm) Cover width	展开宽度 (mm) Coil width	板厚 (mm) Thickness	用途 Usage
RFT160	960	1250	0.45	屋面板 Roof
			0.75	

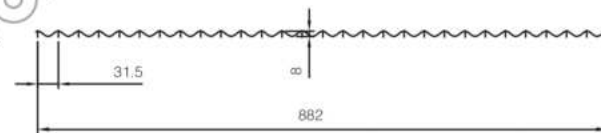

型号 Model	有效覆盖宽度 (mm) Cover width	展开宽度 (mm) Coil width	板厚 (mm) Thickness	用途 Usage
RFT32A	882	1000	0.35	屋面板 Roof
			0.5	

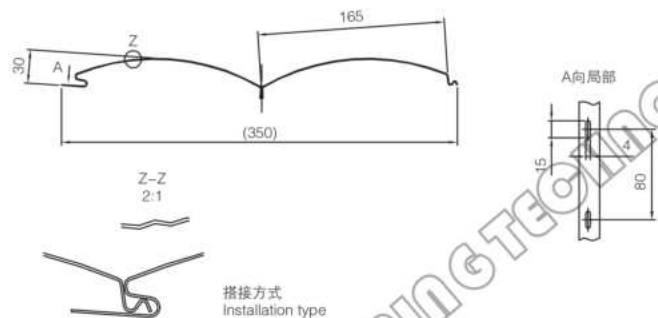

型号 Model	有效覆盖宽度 (mm) Cover width	展开宽度 (mm) Coil width	板厚 (mm) Thickness	用途 Usage
RFT165	350	416	0.45	隐藏式墙面板 Joint-hidden Wall
			0.7	

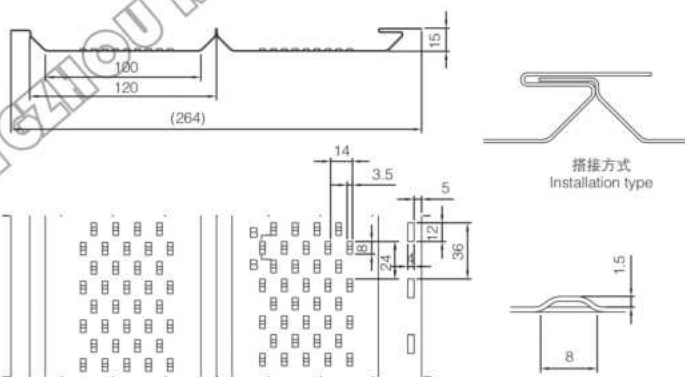

型号 Model	有效覆盖宽度 (mm) Cover width	展开宽度 (mm) Coil width	板厚 (mm) Thickness	用途 Usage
RFT264	264	325	0.45	隐藏式墙面板 Joint-hidden Wall
			0.7	

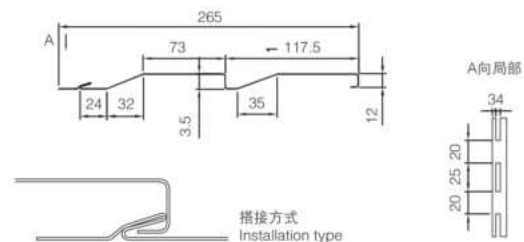

型号 Model	有效覆盖宽度 (mm) Cover width	展开宽度 (mm) Coil width	板厚 (mm) Thickness	用途 Usage
RFT265	265	315	0.4	隐藏式墙面板 Joint-hidden Wall
			0.6	

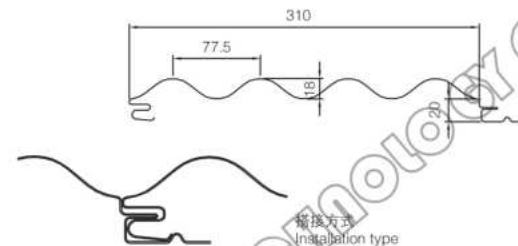

型号 Model	有效覆盖宽度 (mm) Cover width	展开宽度 (mm) Coil width	板厚 (mm) Thickness	用途 Usage
RFT77	310	500	0.5	隐藏式墙面板 Joint-hidden Wall
			0.6	

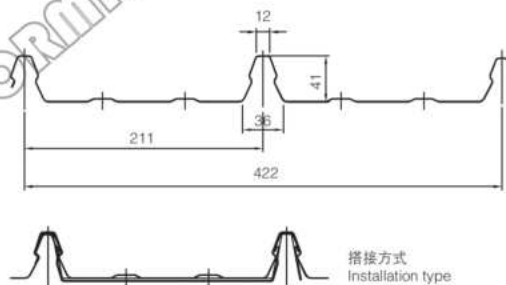

型号 Model	有效覆盖宽度 (mm) Cover width	展开宽度 (mm) Coil width	板厚 (mm) Thickness	用途 Usage
RFT211	422	600	0.4	隐藏式墙面板 Joint-hidden Wall
			0.7	

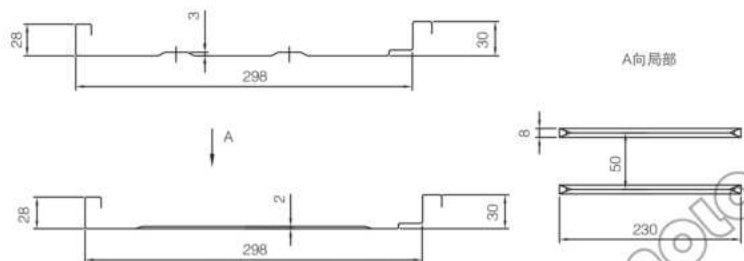

型号 Model	有效覆盖宽度 (mm) Cover width	展开宽度 (mm) Coil width	板厚 (mm) Thickness	用途 Usage
RFT298	298	400	0.65	咬合式墙面板 Self-locked Wall

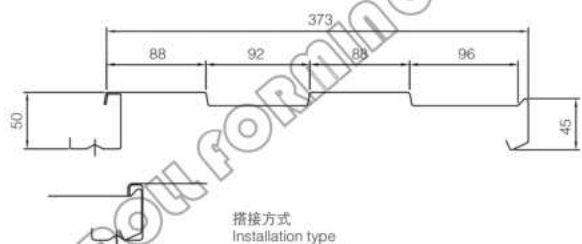

型号 Model	有效覆盖宽度 (mm) Cover width	展开宽度 (mm) Coil width	板厚 (mm) Thickness	用途 Usage
RFT373	373	600	0.4	咬合式墙面板 Self-locked Wall
			0.7	

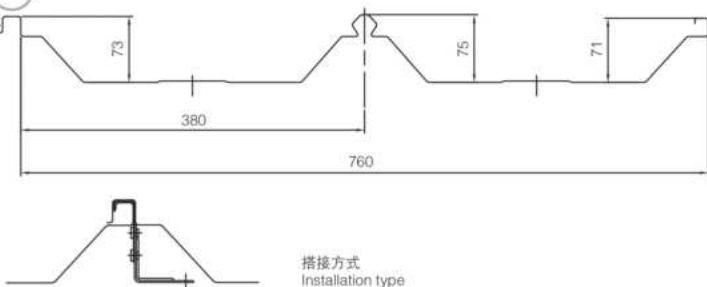

型号 Model	有效覆盖宽度 (mm) Cover width	展开宽度 (mm) Coil width	板厚 (mm) Thickness	用途 Usage
RFT380	760	1000	0.4	咬合式墙面板 Self-locked Wall
			0.7	

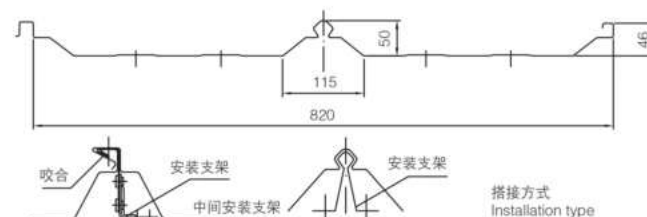

型号 Model	有效覆盖宽度 (mm) Cover width	展开宽度 (mm) Coil width	板厚 (mm) Thickness	用途 Usage
RFT410	820	1000	0.5	咬合式墙面板 Self-locked Wall
			0.8	

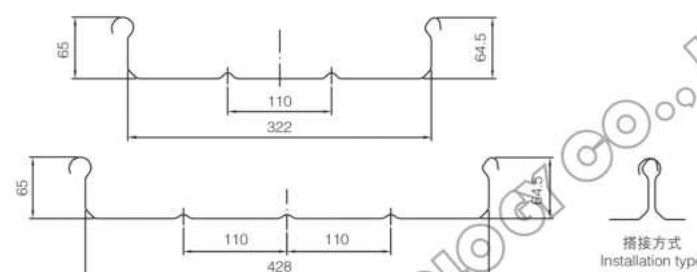

型号 Model	有效覆盖宽度 (mm) Cover width	展开宽度 (mm) Coil width	板厚 (mm) Thickness	用途 Usage
RFT428	322/428	600/600	0.6	咬合式墙面板 Self-locked Wall
			1.0	

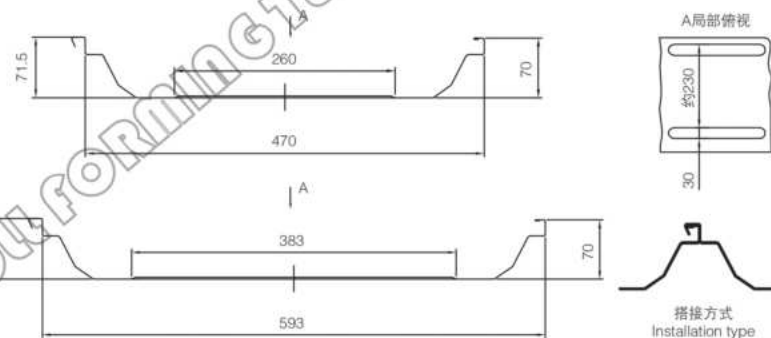

型号 Model	有效覆盖宽度 (mm) Cover width	展开宽度 (mm) Coil width	板厚 (mm) Thickness	用途 Usage
RFT593	470/593	600/725	0.4	咬合式墙面板 Self-locked Wall
			0.7	

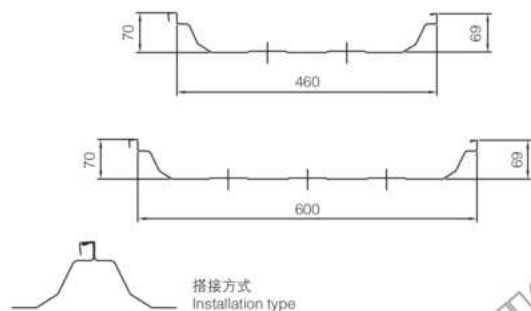

型号 Model	有效覆盖宽度 (mm) Cover width	展开宽度 (mm) Coil width	板厚 (mm) Thickness	用途 Usage
RFT600	460/600	590/730	0.7 0.9	咬合式墙面板 Self-locked Wall

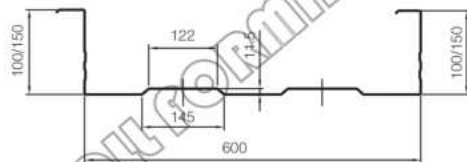

型号 Model	有效覆盖宽度 (mm) Cover width	展开宽度 (mm) Coil width	板厚 (mm) Thickness	用途 Usage
RFT600	600	1000	0.7 0.9	咬合式墙面板 Self-locked Wall

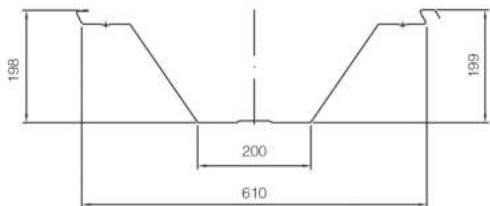

型号 Model	有效覆盖宽度 (mm) Cover width	展开宽度 (mm) Coil width	板厚 (mm) Thickness	用途 Usage
RFT610	610	914	0.8 1.2	咬合式墙面板 Self-locked Wall

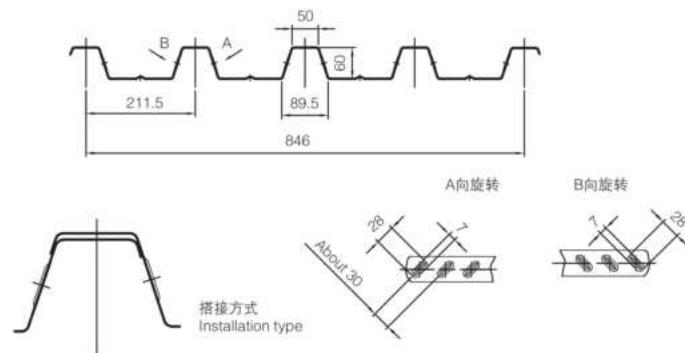

型号 Model	有效覆盖宽度 (mm) Cover width	展开宽度 (mm) Coil width	板厚 (mm) Thickness	用途 Usage
RFT211(H60)	846	1250	0.5 1.0	钢楼板 Deck

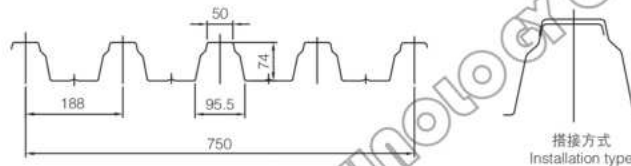

型号 Model	有效覆盖宽度 (mm) Cover width	展开宽度 (mm) Coil width	板厚 (mm) Thickness	用途 Usage
RFT188(H75)	750	1250	0.6 1.0	钢楼板 Deck

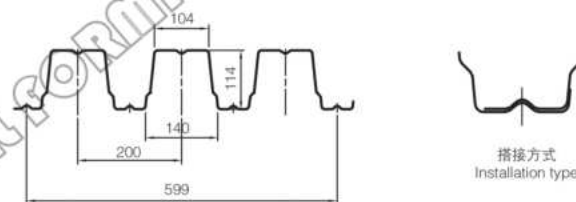

型号 Model	有效覆盖宽度 (mm) Cover width	展开宽度 (mm) Coil width	板厚 (mm) Thickness	用途 Usage
RFT200(H114)	599	1250	0.8 1.2	钢楼板 Deck

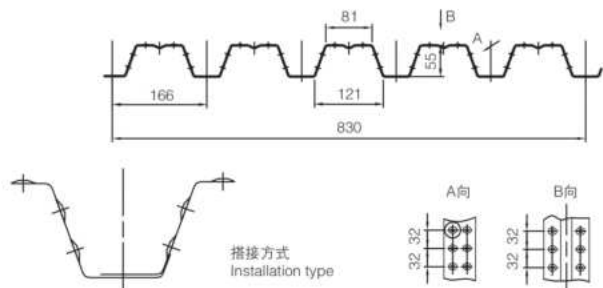

型号 Model	有效覆盖宽度 (mm) Cover width	展开宽度 (mm) Coil width	板厚 (mm) Thickness	用途 Usage
RFT166	830	1250	0.8 1.2	钢楼板 Deck

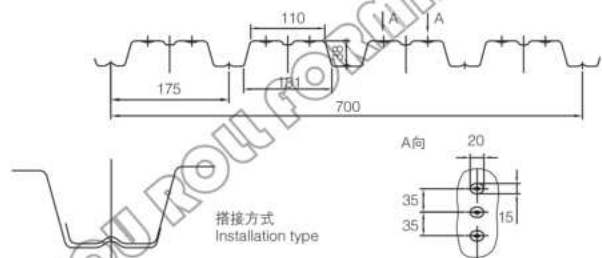

型号 Model	有效覆盖宽度 (mm) Cover width	展开宽度 (mm) Coil width	板厚 (mm) Thickness	用途 Usage
RFT175	700	1000	0.7 1.2	钢楼板 Deck

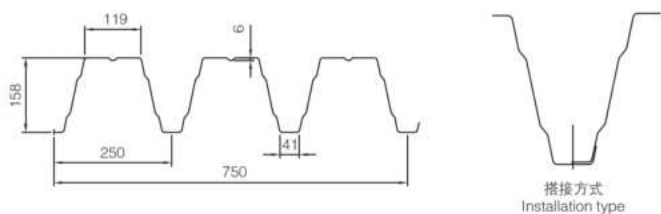

型号 Model	有效覆盖宽度 (mm) Cover width	展开宽度 (mm) Coil width	板厚 (mm) Thickness	用途 Usage
RFT250	750	1500	0.7 1.25	钢楼板 Deck

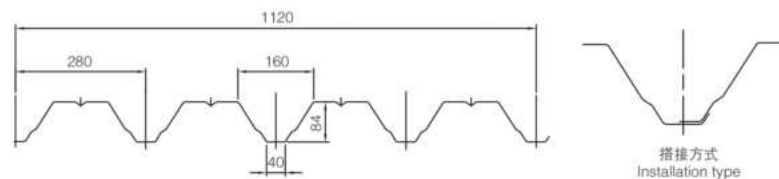

型号 Model	有效覆盖宽度 (mm) Cover width	展开宽度 (mm) Coil width	板厚 (mm) Thickness	用途 Usage
RFT280	1120	1500	0.75 1.25	钢楼板 Deck

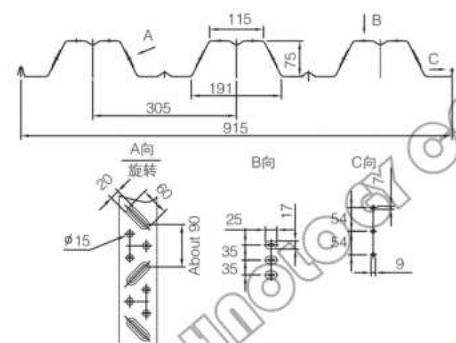

型号 Model	有效覆盖宽度 (mm) Cover width	展开宽度 (mm) Coil width	板厚 (mm) Thickness	用途 Usage
RFT305	915	1250	0.8 1.2	钢楼板 Deck

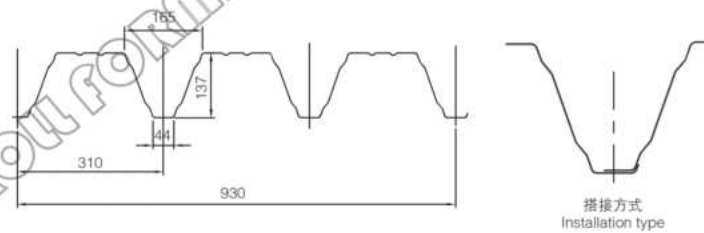

型号 Model	有效覆盖宽度 (mm) Cover width	展开宽度 (mm) Coil width	板厚 (mm) Thickness	用途 Usage
RFT310	930	1500	0.8 1.25	钢楼板 Deck

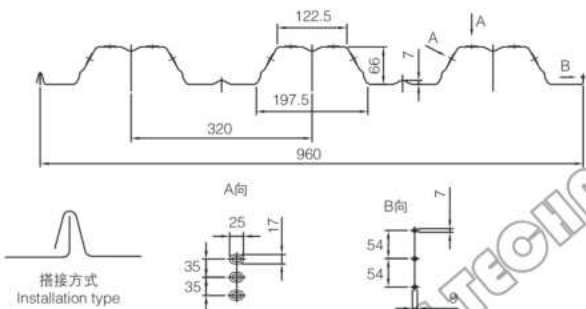

型号 Model	有效覆盖宽度 (mm) Cover width	展开宽度 (mm) Coil width	板厚 (mm) Thickness	用途 Usage
RFT320	960	1250	0.7 1.2	钢楼板 Deck

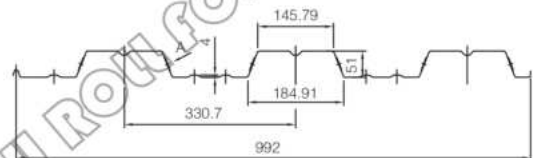

型号 Model	有效覆盖宽度 (mm) Cover width	展开宽度 (mm) Coil width	板厚 (mm) Thickness	用途 Usage
RFT195	585	1125	0.8 1.0	钢楼板 Deck

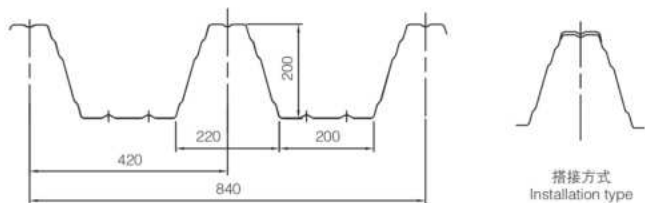

型号 Model	有效覆盖宽度 (mm) Cover width	展开宽度 (mm) Coil width	板厚 (mm) Thickness	用途 Usage
RFT420	840	1500	0.7 1.25	钢楼板 Deck

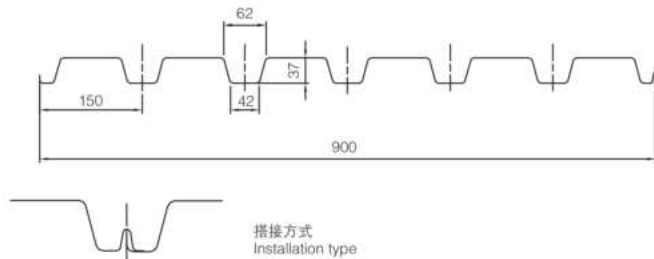

型号 Model	有效覆盖宽度 (mm) Cover width	展开宽度 (mm) Coil width	板厚 (mm) Thickness	用途 Usage
RFT150	900	1250	0.7 1.2	钢楼板 Deck

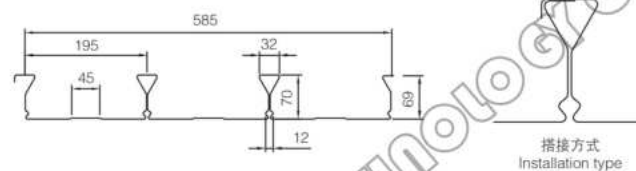

型号 Model	有效覆盖宽度 (mm) Cover width	展开宽度 (mm) Coil width	板厚 (mm) Thickness	用途 Usage
RFT331	992	1250	0.8 1.2	钢楼板 Deck

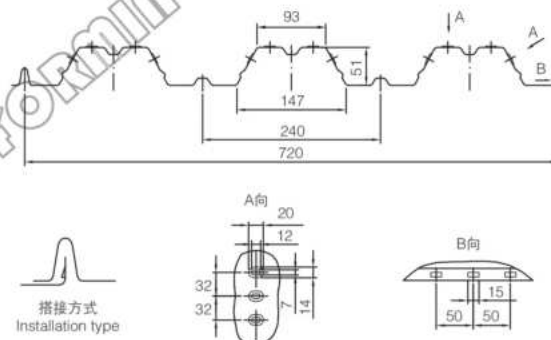

型号 Model	有效覆盖宽度 (mm) Cover width	展开宽度 (mm) Coil width	板厚 (mm) Thickness	用途 Usage
RFT240	720	1000	0.8 1.2	钢楼板 Deck

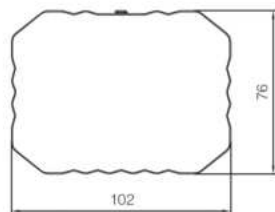

型号 Model	展开宽度 (mm) Coil width	板厚 (mm) Thickness	用途 Usage
RFT102	338	0.5	落水管 Water Pipe
		0.6	

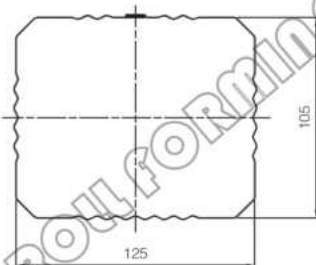

型号 Model	展开宽度 (mm) Coil width	板厚 (mm) Thickness	用途 Usage
RFT126	476	0.5	落水管 Water Pipe

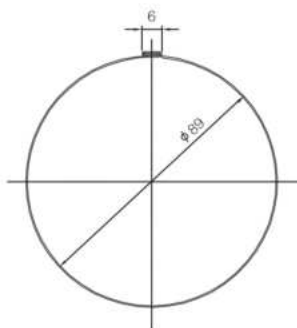

型号 Model	展开宽度 (mm) Coil width	板厚 (mm) Thickness	用途 Usage
RFT89	295	0.5	落水管 Water Pipe
		0.6	

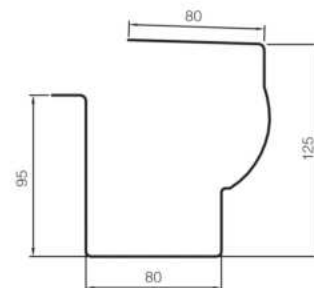

型号 Model	展开宽度 (mm) Coil width	板厚 (mm) Thickness	用途 Usage
RFT80	405	0.4	落水管 Water Pipe
		0.65	

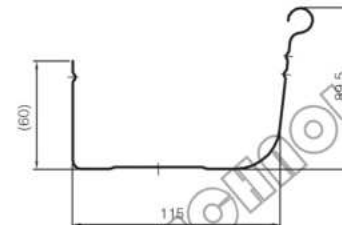

型号 Model	展开宽度 (mm) Coil width	板厚 (mm) Thickness	用途 Usage
RFT115	270	0.42	落水管 Water Pipe

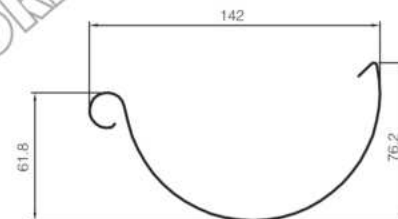

型号 Model	展开宽度 (mm) Coil width	板厚 (mm) Thickness	用途 Usage
RFT142	250	0.5	落水管 Water Pipe
		0.6	

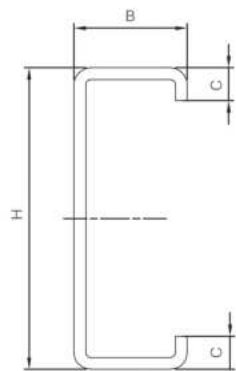

C型檩条规格
Sizes of C-shape purlins

序号 NO	H (mm)	B (mm)	C (mm)	T (mm)	L (mm)	展开长度(mm) Coil width	备注 Remark RFT300
1	80	40	15	2.0-3.0	40-220	172	○
2	100	40	15	2.0-3.0	40-220	192	√
	100	50	20	2.0-3.0	40-220	222	√
	100	60	20	2.0-3.0	40-220	242	√
3	120	60	20	2.0-3.0	40-220	242	√
	120	60	20	2.0-3.0	40-220	262	√
4	140	50	20	2.0-3.0	40-220	262	√
	140	60	20	2.0-3.0	40-220	282	√
5	160	60	20	2.0-3.0	40-220	302	√
	160	70	20	2.0-3.0	40-220	322	√
	180	60	20	2.0-3.0	40-220	322	√
6	180	70	20	2.0-3.0	40-220	342	√
	200	60	20	2.0-3.0	40-220	342	√
7	200	70	20	2.0-3.0	40-220	362	√
	220	70	20	2.0-3.0	40-220	382	√
8	220	80	20	2.0-3.0	40-220	402	√
	240	70	20	2.0-3.0	40-220	402	√
9	240	80	20	2.0-3.0	40-220	422	√
	250	80	20	2.0-3.0	40-220	432	○
11	260	80	20	2.0-3.0	40-220	442	○
12	280	80	20	2.0-3.0	40-220	462	○
13	300	80	20	2.0-3.0	40-220	482	○

注：1、带“√”的檩条规格为标准配置
2、带“○”的檩条规格为选择配置

Note: 1. The size with "√" is company's standard configuration.
2. The size with "○" is optional configuration.

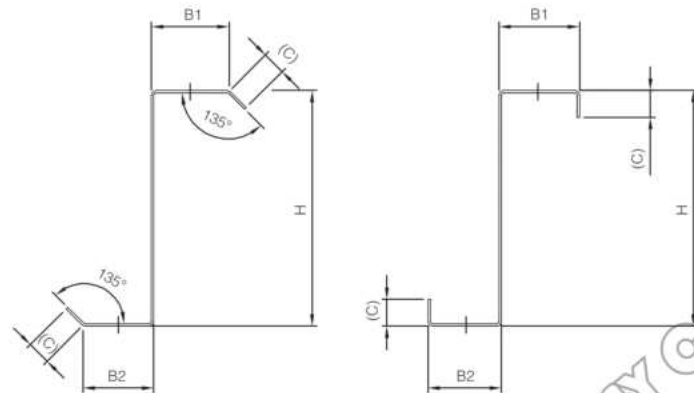

Z型檩条规格
Sizes of Z-shape purlins

序号 NO	A (mm)	B (mm)	C (mm)	T (mm)	L (mm)	展开长度(mm) Coil width	备注 Remark RFT300
1	100	54	50	2.0-3.0	40-300	234	√
2	120	64	60	2.0-3.0	40-300	274	√
3	140	64	60	2.0-3.0	40-300	294	√
4	160	74	70	2.0-3.0	40-300	334	√
5	180	74	70	2.0-3.0	54-300	354	√
6	200	74	70	2.0-3.0	74-300	374	√
	220	84	80	2.0-3.0	114-300	414	√
8	240	84	80	2.0-3.0	134-300	434	√
9	260	84	80	2.0-3.0	154-300	454	○
10	280	84	80	2.0-3.0	174-300	474	○
11	300	84	80	2.0-3.0	194-300	494	○

注：1、带“√”的檩条规格为标准配置
2、带“○”的檩条规格为选择配置

Note: 1. The size with "√" is company's standard configuration.
2. The size with "○" is optional configuration.

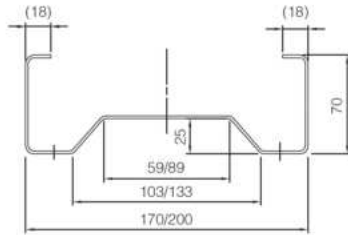

型号 Model	有效覆盖宽度 (mm) Cover width	展开宽度 (mm) Coil width	板厚 (mm) Thickness
RFT200	170/200	348/378	1.5 2.0

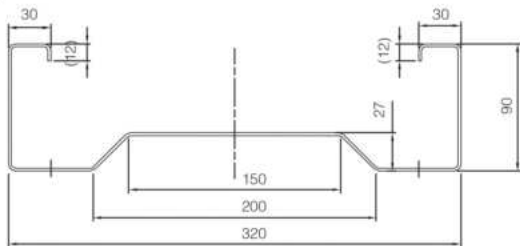
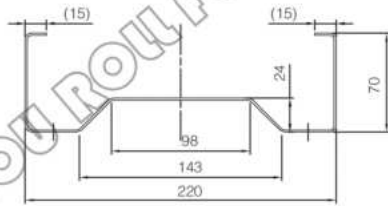

型号 Model	有效覆盖宽度 (mm) Cover width	展开宽度 (mm) Coil width	板厚 (mm) Thickness
RFT-320(220)	320/220	580/395	1.5 2.0

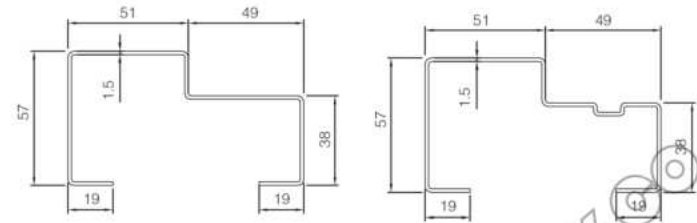
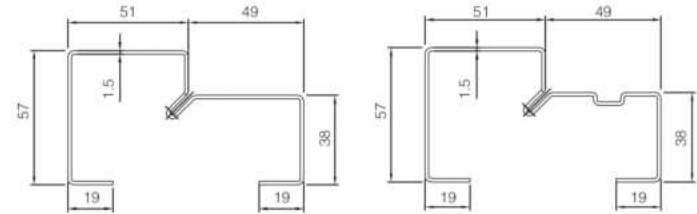

型号 Model	有效覆盖宽度 (mm) Cover width	展开宽度 (mm) Coil width	板厚 (mm) Thickness	用途 Usage
RFT57	100	300	1.0-2.0	门框 Door frame

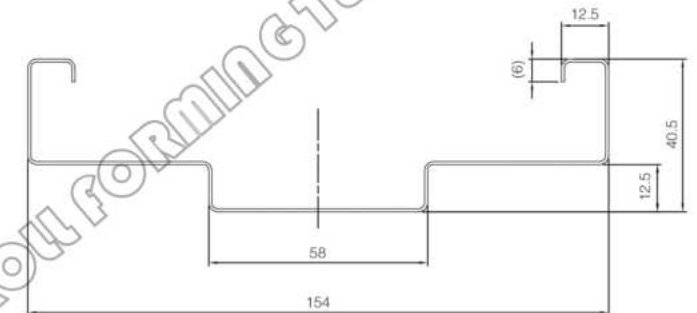

型号 Model	有效覆盖宽度 (mm) Cover width	展开宽度 (mm) Coil width	板厚 (mm) Thickness	用途 Usage
RFT154	154	255	0.46-0.8	门框 Door frame

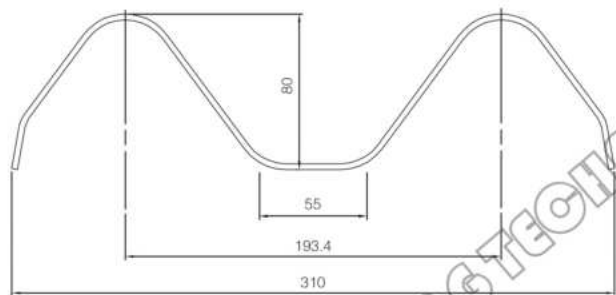

型号 Model	有效覆盖宽度 (mm) Cover width	展开宽度 (mm) Coil width	板厚 (mm) Thickness	用途 Usage
RFT310	310	468	3	公路护栏板 Guard Rail

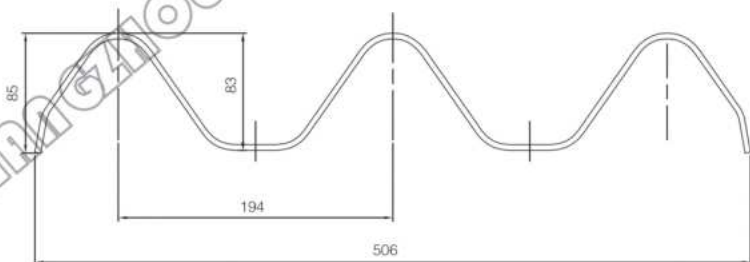

型号 Model	有效覆盖宽度 (mm) Cover width	展开宽度 (mm) Coil width	板厚 (mm) Thickness	用途 Usage
RFT506	506	748	4	公路护栏板 Guard Rail

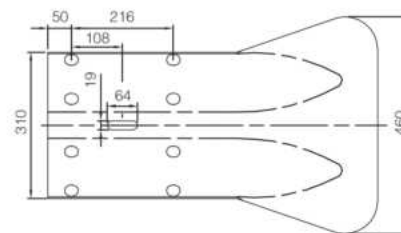
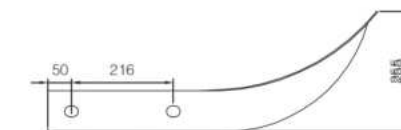

RFT-A

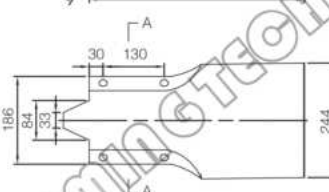
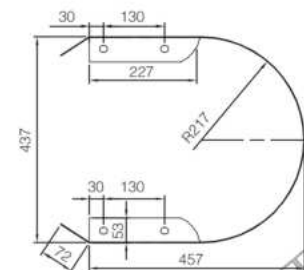

RFT-B

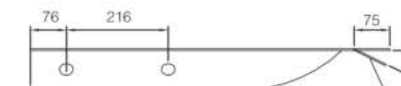
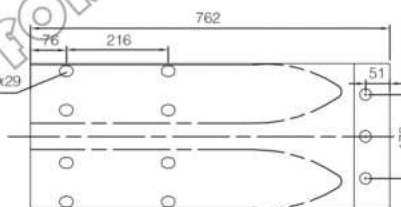

RFT-C



展开图 Layout Drawings

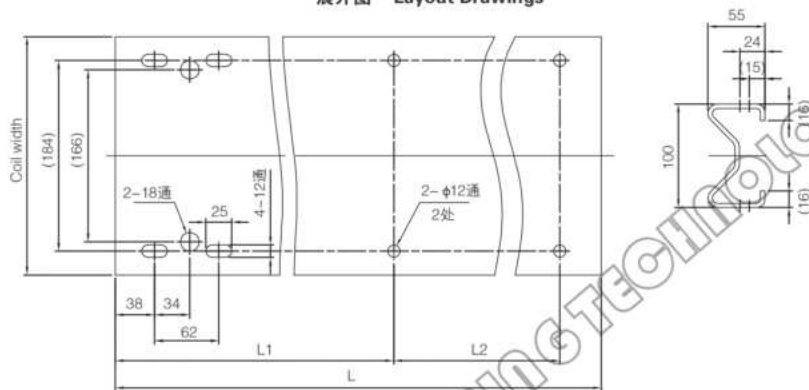

型号 Model	有效覆盖宽度 (mm) Cover width	展开宽度 (mm) Coil width	板厚 (mm) Thickness	用途 Usage
RFT100	100	230	4.0-5.0	护栏板立柱 Guardrail Column

展开图 Layout Drawings

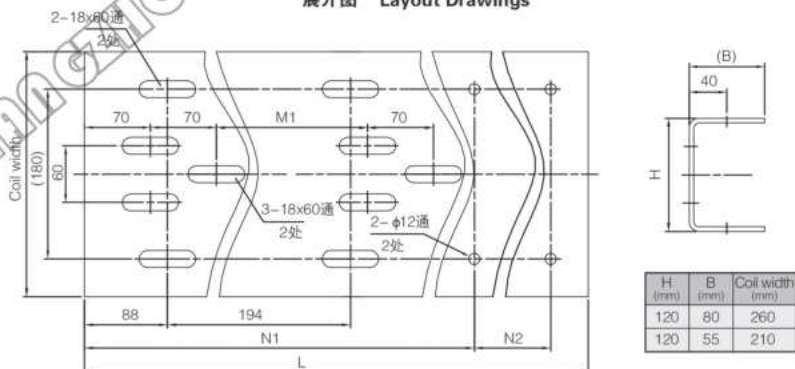

型号 Model	有效覆盖宽度 (mm) Cover width	展开宽度 (mm) Coil width	板厚 (mm) Thickness	用途 Usage
RFT120	120	210/260	4.0-5.0	护栏板立柱 Guardrail Column



展开图 Layout Drawings

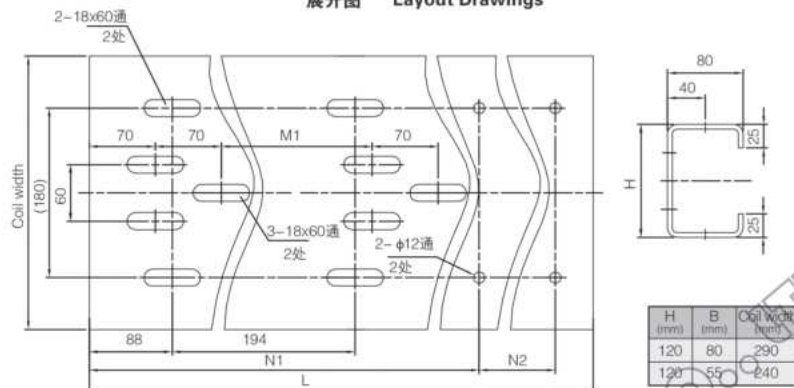

型号 Model	有效覆盖宽度 (mm) Cover width	展开宽度 (mm) Coil width	板厚 (mm) Thickness	用途 Usage
RFT120	120	240/290	4.0-5.0	护栏板立柱 Guardrail Column

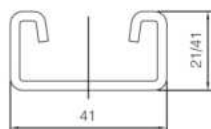

型号 Model	有效覆盖宽度 (mm) Cover width	展开宽度 (mm) Coil width	板厚 (mm) Thickness
RFT41	41	96/136	2 2.5

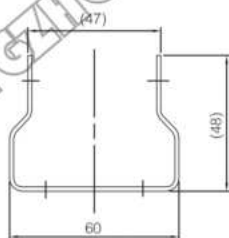

型号 Model	有效覆盖宽度 (mm) Cover width	展开宽度 (mm) Coil width	板厚 (mm) Thickness
RFT60	60	152	1.5

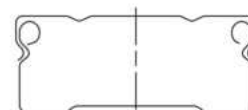
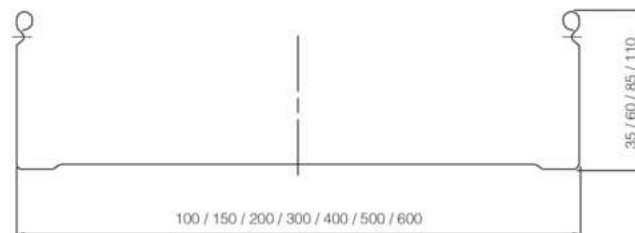

搭接方式
Installation type

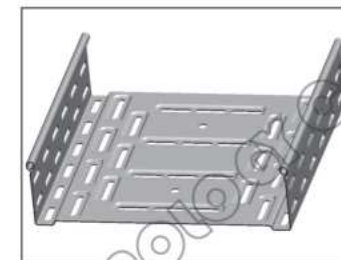

型号 Model	有效覆盖宽度 (mm) Cover width	展开宽度 (mm) Coil width	板厚 (mm) Thickness	用途 Usage
RFT600	100-600	198-848	1.0 1.2	走线槽 Cable trough

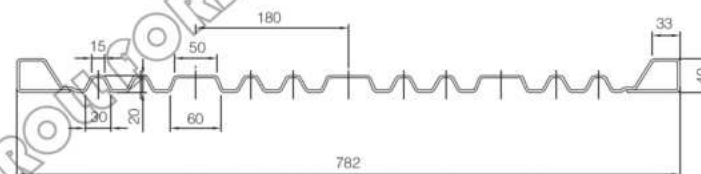

型号 Model	有效覆盖宽度 (mm) Cover width	展开宽度 (mm) Coil width	板厚 (mm) Thickness	用途 Usage
RFT782	782	1200	2.0 3.0	集装箱板 Container Panel

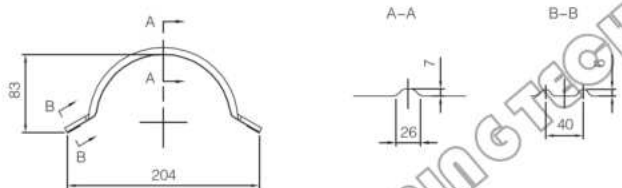
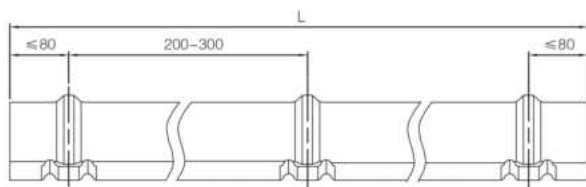

型号 Model	有效覆盖宽度 (mm) Cover width	展开宽度 (mm) Coil width	板厚 (mm) Thickness
RFT204	204	312	0.4
			0.6

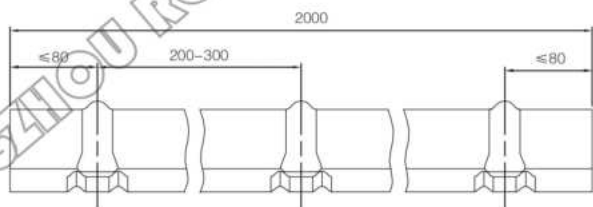

型号 Model	有效覆盖宽度 (mm) Cover width	展开宽度 (mm) Coil width	板厚 (mm) Thickness
RFT228	228	305	0.4
			0.8

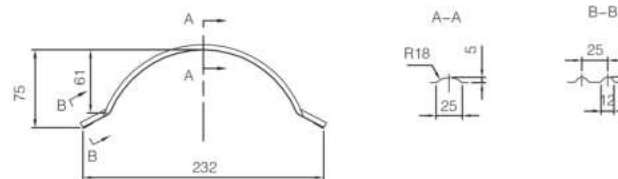
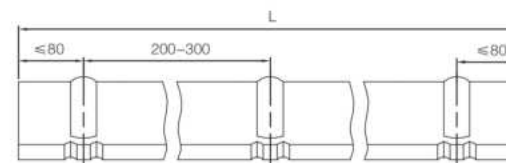

型号 Model	有效覆盖宽度 (mm) Cover width	展开宽度 (mm) Coil width	板厚 (mm) Thickness
RFT232	232	310	0.4
			0.8

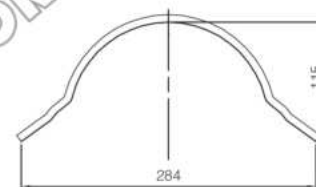
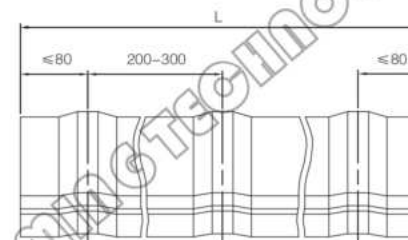

型号 Model	有效覆盖宽度 (mm) Cover width	展开宽度 (mm) Coil width	板厚 (mm) Thickness
RFT284	284	385	0.5
			0.6

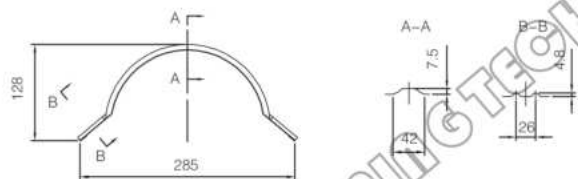
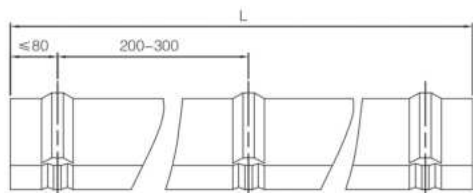

型号 Model	有效覆盖宽度 (mm) Cover width	展开宽度 (mm) Coil width	板厚 (mm) Thickness
RFT285	285	420	0.5
			0.55

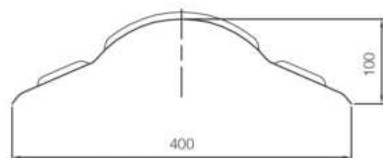
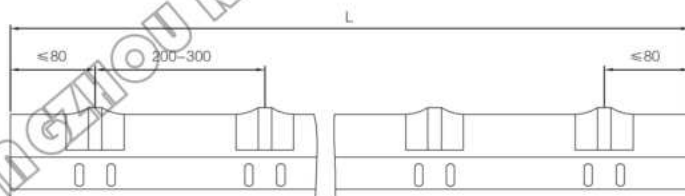

型号 Model	有效覆盖宽度 (mm) Cover width	展开宽度 (mm) Coil width	板厚 (mm) Thickness
RFT400	400	457	0.4
			0.6

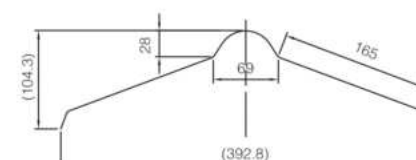
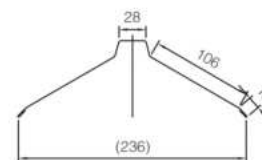

型号 Model	展开宽度 (mm) Coil width	板厚 (mm) Thickness
RFT232	312	0.35-0.6

型号 Model	展开宽度 (mm) Coil width	板厚 (mm) Thickness
RFT165	460	0.5-0.6

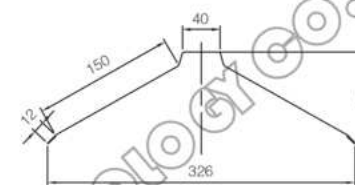
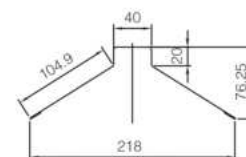

型号 Model	展开宽度 (mm) Coil width	板厚 (mm) Thickness
RFT218	312	0.35-0.6

型号 Model	展开宽度 (mm) Coil width	板厚 (mm) Thickness
RFT326	410	0.5-0.55

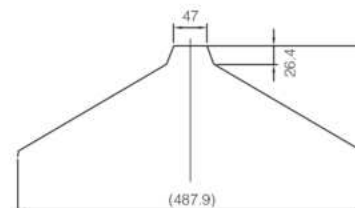
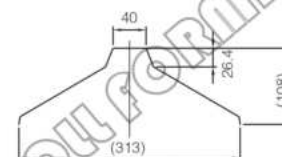

型号 Model	有效覆盖宽度 (mm) Cover width	展开宽度 (mm) Coil width	板厚 (mm) Thickness
RFT487	313/487	400/600	0.3
			0.5

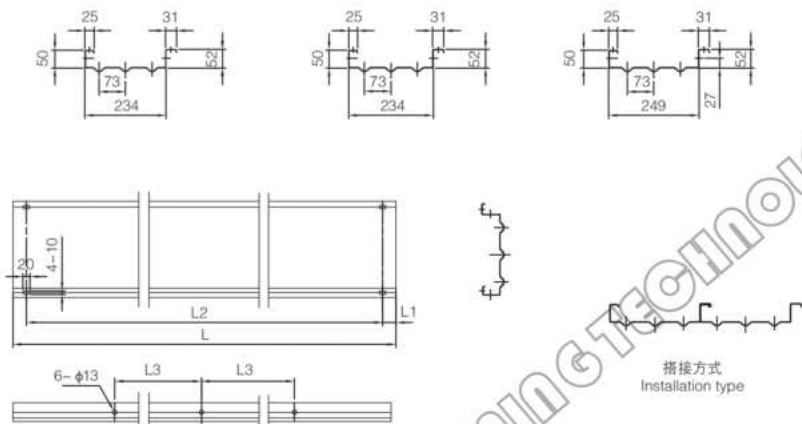

型号 Model	有效覆盖宽度 (mm) Cover width	展开宽度 (mm) Coil width	板厚 (mm) Thickness
RFT249	224/234/249	390/400/415	2.0
			2.3

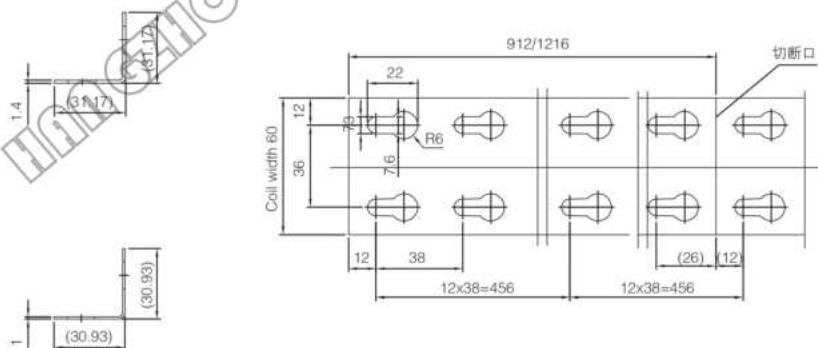

型号 Model	有效覆盖宽度 (mm) Cover width	展开宽度 (mm) Coil width	板厚 (mm) Thickness
RFT31	31	60	1.0
			1.4

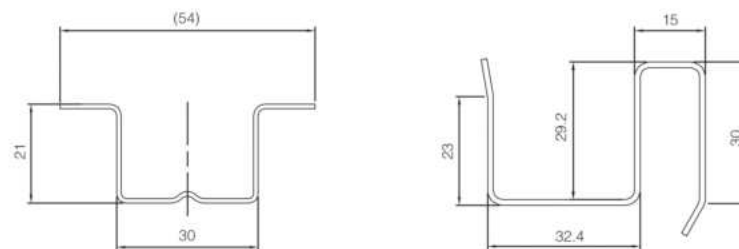

型号 Model	展开宽度 (mm) Coil width	板厚 (mm) Thickness
YKA30	90	0.8-0.95

型号 Model	展开宽度 (mm) Coil width	板厚 (mm) Thickness
YKA32	135	1.2

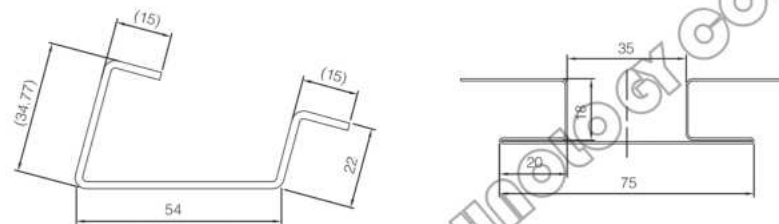

型号 Model	展开宽度 (mm) Coil width	板厚 (mm) Thickness
RFT54A	129	1.5-2.26

型号 Model	展开宽度 (mm) Coil width	板厚 (mm) Thickness
RFT75	208	0.4-0.6

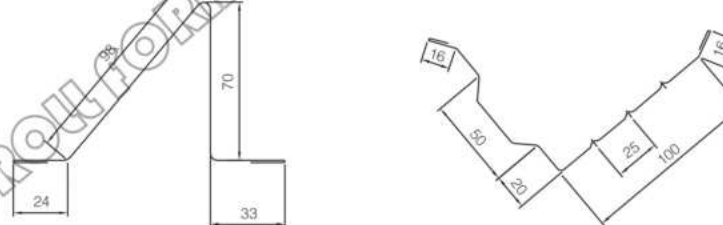

型号 Model	展开宽度 (mm) Coil width	板厚 (mm) Thickness
RFT98	250	0.35-0.6

型号 Model	展开宽度 (mm) Coil width	板厚 (mm) Thickness
RFT100	250	0.35-0.6

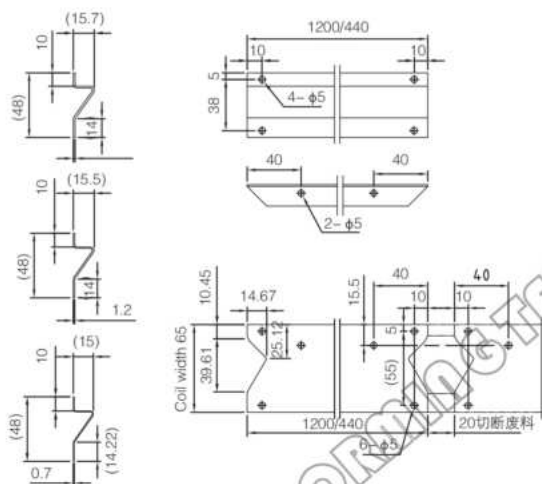

型号 Model	有效覆盖宽度 (mm) Cover width	展开宽度 (mm) Coil width	板厚 (mm) Thickness
RFT48	48	65	0.7 1.4

A向 底面压花图
Embossing drawings

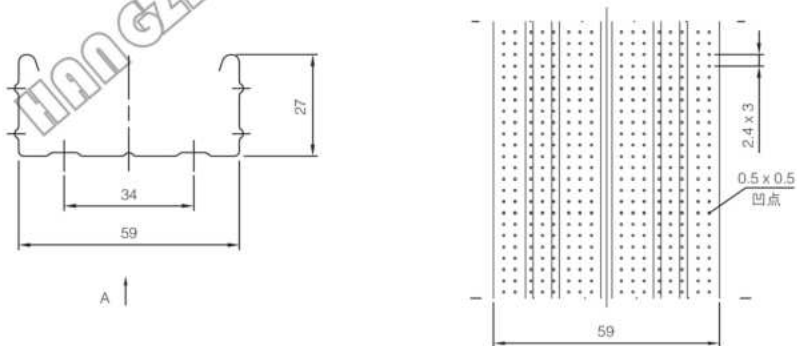

型号 Model	有效覆盖宽度 (mm) Cover width	展开宽度 (mm) Coil width	板厚 (mm) Thickness
RFT60	60	127	0.5

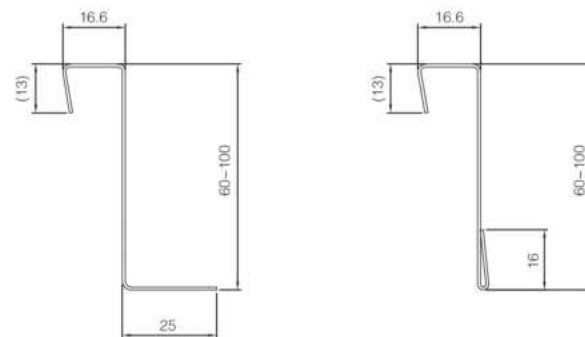

Coil width 108-148mm

Coil width 102-142mm

型号 Model	有效覆盖宽度 (mm) Cover width	展开宽度 (mm) Coil width	板厚 (mm) Thickness
RFT100	60-100	102-148	0.5 0.8

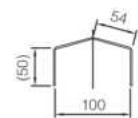

Coil width 201mm

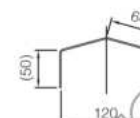

Coil width 222mm

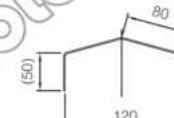

Coil width 253mm

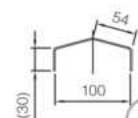

Coil width 164mm

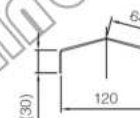

Coil width 182mm

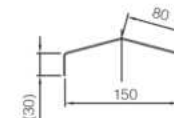

Coil width 213mm

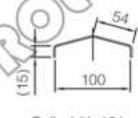

Coil width 131mm

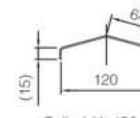

Coil width 152mm

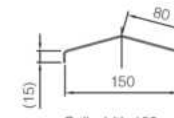

Coil width 183mm

型号 Model	有效覆盖宽度 (mm) Cover width	展开宽度 (mm) Coil width	板厚 (mm) Thickness
RFT150	100-150	131-253	1.5-2.25